



# MODELO PRT7-2B

PRT7-2B MODEL

## SOQUETE DE CONEXÃO TIPO PARAFUSO

SCREW TYPE TERMINAL SOCKET

### ESPECIFICAÇÕES TÉCNICAS

TECHNICAL SPECIFICATIONS

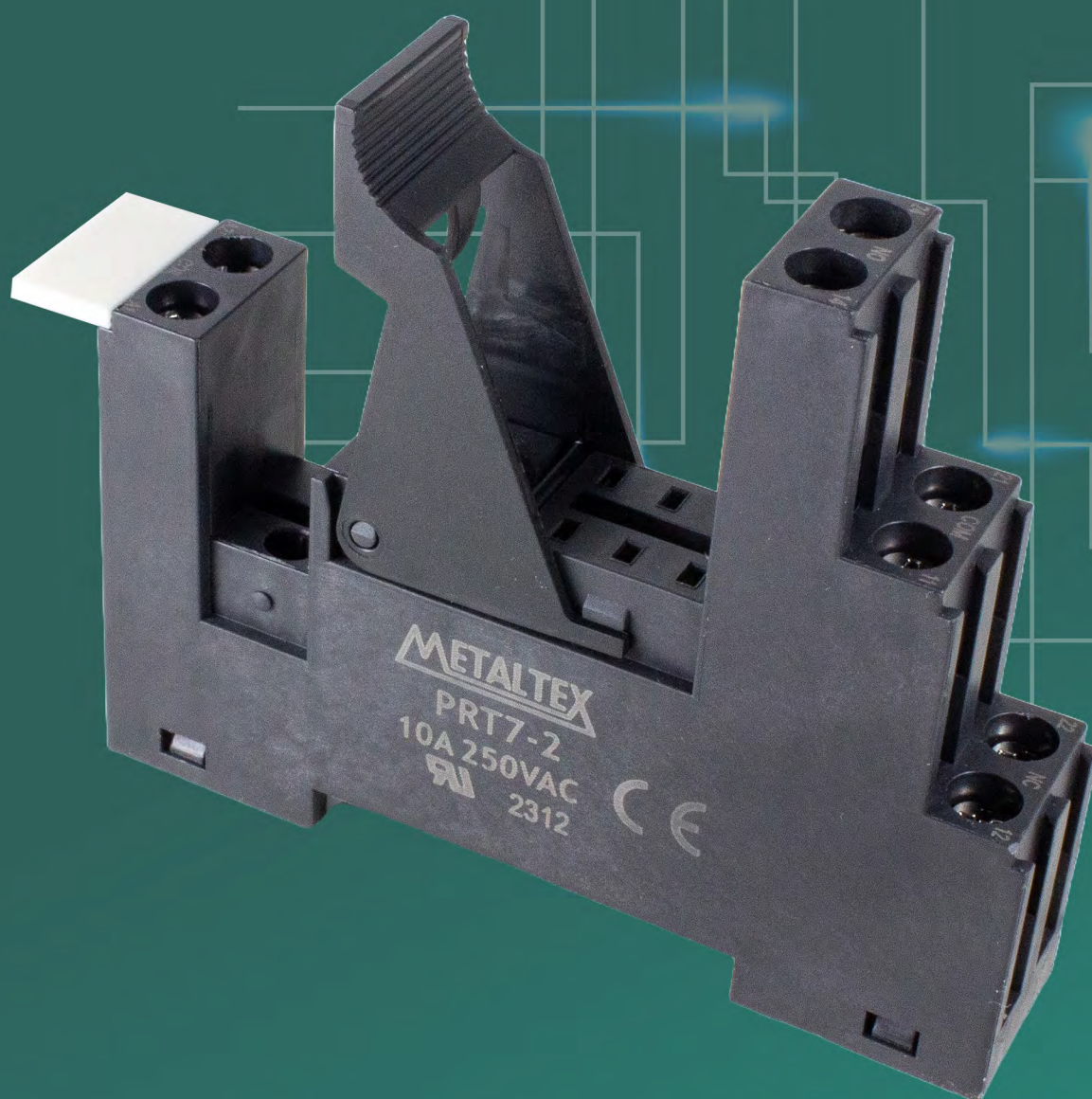

## PRINCIPAIS CARACTERÍSTICAS / MAIN CHARACTERISTICS

- Aplicável a relés de 8 terminais;  
*Applicable to 8 terminal relays;*
- Séries de relés Metaltex compatíveis: JX2, JXD, JXE2 e JXE1RP;  
*Compatible Metaltex relay series: JX2, JXD, JXE2 and JXE1RP;*
- Montagem em trilho DIN 35 x 7,5 mm;  
*DIN rail 35 x 7.5 mm mounting;*
- Conexões de bobina e contatos em lados opostos. Permite a separação de comando e potência em canaletas diferentes no painel;  
*Coil and contact connections on opposite sides. Allows the separation of control and power wiring into different cable channels on the panel;*
- Acompanha clip de retenção e extração plástico, para relés de perfil baixo (h=15,7 mm);  
*Includes plastic retention and extraction clip, for low profile case relays (h=15,7 mm);*
- Conexão por parafusos;  
*Screw type terminal socket;*
- Disponíveis módulos de sinalização e proteção para uso integrado;  
*Coil indication and EMC suppression modules are available;*
- Acompanha identificador plástico branco;  
*Includes white plastic identifier;*



UL File No. E319814

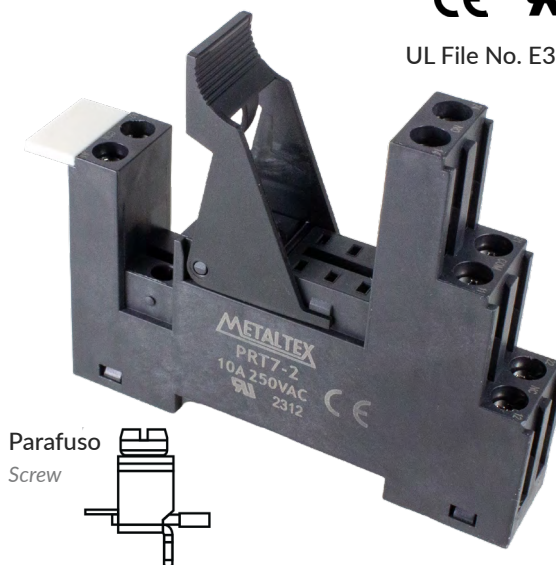

CÓDIGO DE COMPRA / HOW TO ORDER

PRT7-2B

## ESPECIFICAÇÕES GERAIS / GENERAL SPECIFICATIONS

Tensão nominal / <i>Rated voltage</i>	250 VCA / VCC / VAC / VDC
Corrente nominal / <i>Rated current</i>	10 A (por polo / <i>per pole</i> )*
Tensão de isolamento (mín.) / <i>Insulation voltage (min.)</i>	5000 VCA / VAC
Grau de proteção / <i>Protection category</i>	IP20
Temperatura operacional / <i>Operating temperature</i>	-40 ~ +70 °C
Comprimento de desnudamento do cabo / <i>Wire strip length</i>	7 mm
Bitola máxima de cabos aplicável / <i>Maximum applicable cable gauge</i>	2x1,5 ou 1x2,5 mm <sup>2</sup> / 2x AWG#16 or 1x AWG#14 (fio rígido ou flexível / <i>solid or stranded wire</i> )
Material da carcaça / <i>Shell material</i>	PA6 + GF (V0)
Material dos parafusos combi M3 e das gaiolas <i>Material of M3 combi screws and cages</i>	Aço carbono niquelado / <i>Nickel plated carbon steel</i>
Torque de aperto / <i>Screw torque</i>	0.5 Nm
Peso unitário / <i>Unit weight</i>	48g

## DIAGRAMA DE CONEXÕES / CONNECTIONS DIAGRAM

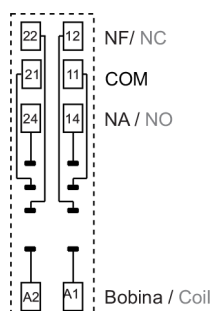

\* Para correntes > 10 A, os terminais de contato devem ser conectados em paralelo (21 com 11, 24 com 14, 22 com 12).

\* For currents > 10 A, contact terminals must be connected in parallel (21 with 11, 24 with 14, 22 with 12).

Situação exemplo: Relés com configuração de 1 contato reversível, 16 A, pinos duplos.

Example situation: Relays with configuration of SPDT contact, 16 A, double pins.



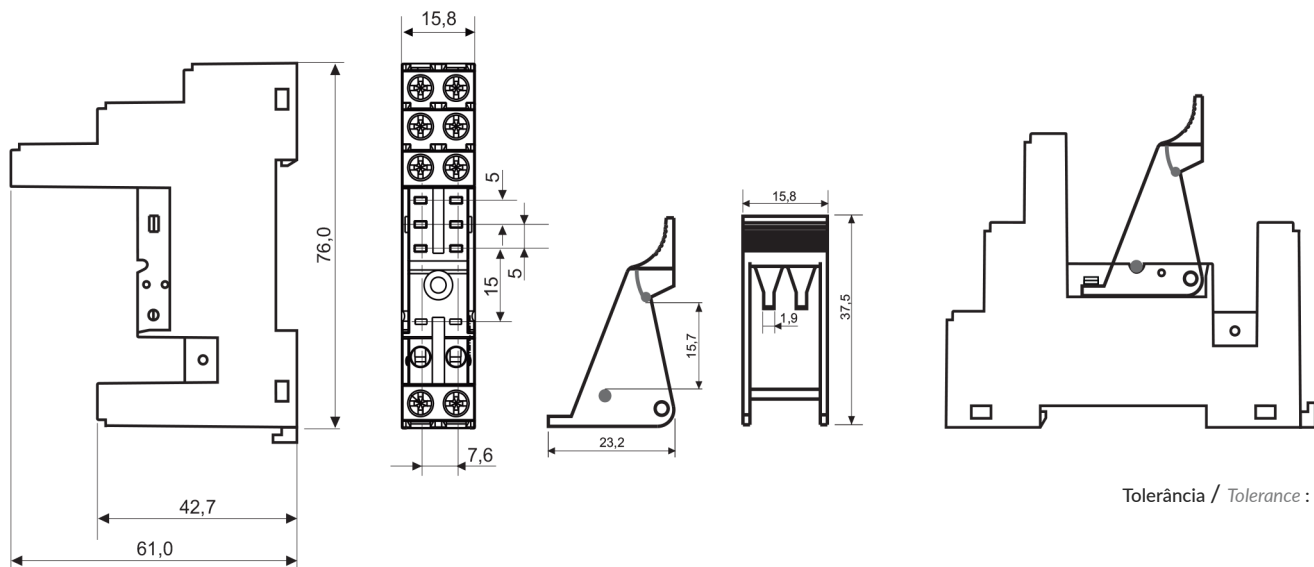



DIMENSÕES / DIMENSIONS (mm)

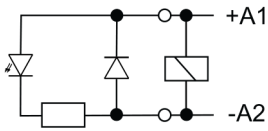
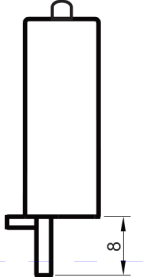

Tolerância / Tolerance : ± 0,20 mm

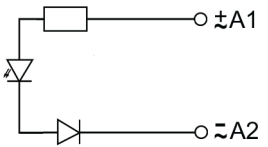
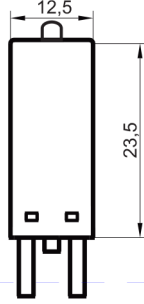
ACESSÓRIOS / ACCESSORIES

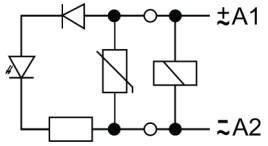
MÓDULOS DE SINALIZAÇÃO E PROTEÇÃO / COIL INDICATION AND EMC SUPPRESSION MODULES

Código Part number	Faixa de tensão operacional Operating voltage range	Diagrama de circuito Circuit diagram	Descritivo funcional Functional description	Dimensões Dimensions
 <p>PRT7G-C</p>	6 ~ 24 VCC / VDC		<p>LED (verde / green) Indicador de status da bobina Coil status indicator + Diodo / Diode Supressão de tensão reversa Reverse voltage suppression</p>	
 <p>PRT7G-C1</p>	24 ~ 60 VCC / VDC			
 <p>PRT7R-A</p>	110 ~ 230 VCA / VCC VAC / VDC		<p>LED (vermelho / red) Indicador de status da bobina Coil status indicator</p>	
 <p>PRT7R-AL</p>	6 ~ 24 VCA / VCC VAC / VDC		<p>LED (vermelho / red) Indicador de status da bobina Coil status indicator + Varistor Supressão de transientes da bobina Coil transient suppression</p>	
 <p>PRT7R-AH</p>	110 ~ 230 VCA / VCC VAC / VDC			

Peso / Weight: 3g